

Product Data Sheet

NSB 60FT Silver



Specifically designed
for semi-stable
mains applications



- Long design life
- High cycling and fast recharge performance
- State of the art manufacturing automation ensures consistency and reliability
- Advanced 3 stage terminal design to ensure leak free operation
 - Female M8 brass terminals provide maximum performance
- High modulus polyphenylene plastic materials designed to withstand extended elevated operating temperatures and maintain high battery compression essential for reliable operation
- Thermally sealed plastic casing and cover
 - Flame retardant (UL 94 VO) and LOI of at least 28%
- Integral handles and front access terminals ensure ease of installation and maintenance
- 2 year shelf life at 25°C (77°F)
- Approved as non-hazardous cargo for ground, sea, and air transport
 - DOT 49CFR173.159(d), (i) and (ii)



Product Data Sheet

NSB 60FT Silver



Technical Specifications

	International Standards 20°C (68°F)	NA Standards 77°F (25°C)
8 hour capacity to 1.75 Volts/Cell	57 Ah	58 Ah
10 hour capacity to 1.80 Volts/Cell	57 Ah	58 Ah
Float Voltage	2.29 +/- 0.02 Volts/Cell	2.27 +/- 0.02 Volts/Cell
Nominal Voltage	12 V	
Impedance (1kHz)	4.3 mΩ @ 25 °C (77 °F)	
Conductance	1063 S	
Short Circuit Current	2,100 A	

Measurements

Height	263 mm (10.4 in)
Width	108 mm (4.2 in)
Depth	287 mm (11.3 in)
Weight	22 kg (48 lbs)
Terminal	Female M8 leak proof
Terminal Torque	8.0 Nm (71 in-lbs)

Ah Capacity Ratings at 25°C (77°F)

Capacity discharge (hours)	1	2	4	8	10
Capacity @ 25°/Ah	43	48	54	58	58
End of discharge (Volts)	1.70	1.75	1.75	1.75	1.80

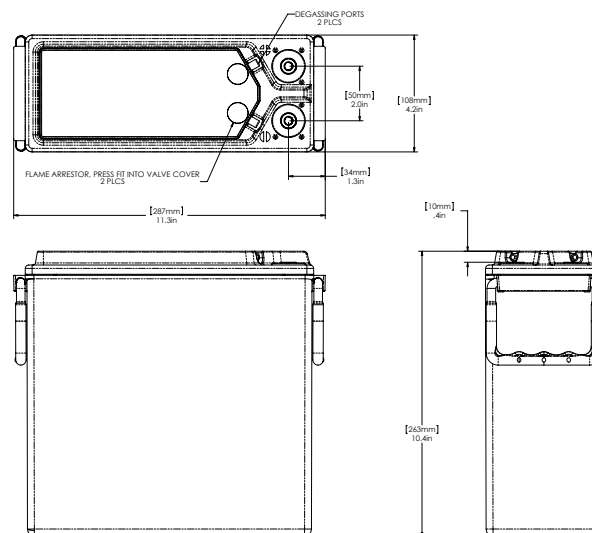

NorthStar in the Americas
NorthStar Battery Company LLC
4000 Continental Way
Springfield, MO 65803
USA
Tel: (+1) 417 575 8200
Fax: (+1) 417 575 8250
info@northstarbattery.com
www.northstarbattery.com

NorthStar in Europe, Africa,
Middle East
SiteTel Sweden AB
Staffans Väg 6-8
Box 7039
SE-192 07 Sollentuna
Sweden
Tel. +46 8 410 102 00
Fax. +46 8 638 06 00
europe@northstarbattery.com

NorthStar in Asia-Pacific
SiteTel Shanghai Co Ltd
Building 9, 1201 Gui Qiao Road
Jin Qiao Export Process Zone
201206 Shanghai
China
Tel. +86 21 5899 7610
Fax. +86 21 3872 2201
asia@northstarbattery.com



Form: SES-542-02-03 Issued: 10-13-10 ECO: 1374-S10

All NorthStar products are compliant with:

- Telcordia SR4228, Bellcore GR-63-Core, Issue 1
- British, German, and Russian telecom standards
- UL Approved

NorthStar is Registered to ISO 9001 & ISO 14001